

KBU35005-G Thru. KBU3510-G

Reverse Voltage: 50 to 1000V

Forward Current: 35.0A

RoHS Device

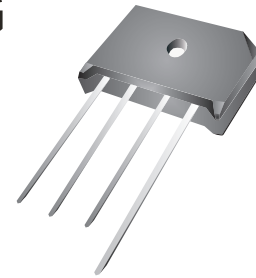

Features

- Surge overload rating - 400 amperes peak.
- Ideal for printed circuit board.
- Plastic material has U/L flammability classification 94V-0

Mechanical Data

- Case: Molded plastic, KBU
- Mounting position: Any
- Weight: 7.40grams

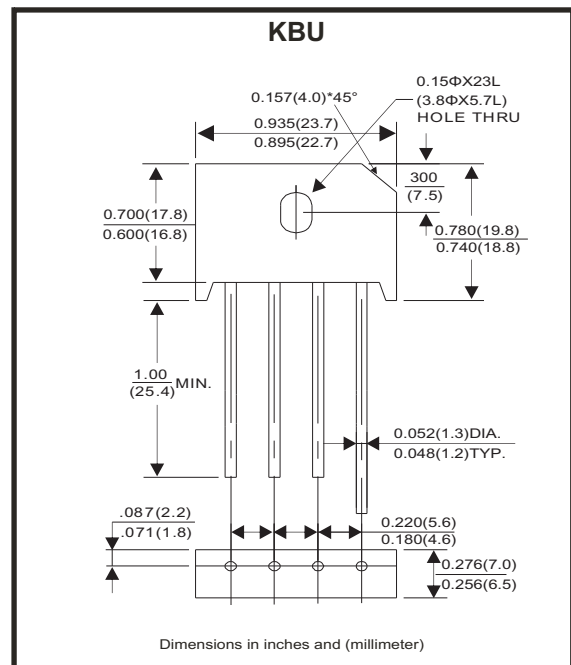

Maximum ratings and electrical characteristics

Rating at 25°C ambient temperature unless otherwise specified.
 Single phase, half wave, 60Hz, resistive or inductive load.
 For capacitive load, derate current by 20%

Parameter	Symbol	KBU 35005-G	KBU 3501-G	KBU 3502-G	KBU 3504-G	KBU 3506-G	KBU 3508-G	KBU 3510-G	Unit
Maximum Reverse Peak Repetitive Voltage	V_{RRM}	50	100	200	400	600	800	1000	V
Maximum RMS Bridge Input Voltage	V_{RMS}	35	70	140	280	420	560	700	V
Maximum DC Blocking Voltage	V_{DC}	50	100	200	400	600	800	1000	V
Maximum Average Forward (With heatsink Note1) Rectified Current @ $T_c=100^\circ\text{C}$ (without hestsink)	I_{AV}	35.0 4.2							A
Peak Forward Surge Current, 8.3ms Single Half Sine-Wave Super Imposed On Rated Load	I_{FSM}	400							A
Maximum Forward Voltage at 17.5A DC	V_F	1.1							V
Maximum Reverse Current @ $T_J=25^\circ\text{C}$ At Rate DC Blocking Voltage @ $T_J=125^\circ\text{C}$	I_R	10.0 500							μA
Operating Temperature Range	T_J	-55 to +125							$^\circ\text{C}$
Storage Temperature Range	T_{STG}	-55 to +150							$^\circ\text{C}$

Notes:

1. Device mounted on 100mm*100mm*1.6mm Cu plate heatsink.

Rating and Characteristics Curves (KBU35005-G Thru. KBU3510-G)

Fig.1 - Derating Curve Output Rectified Current

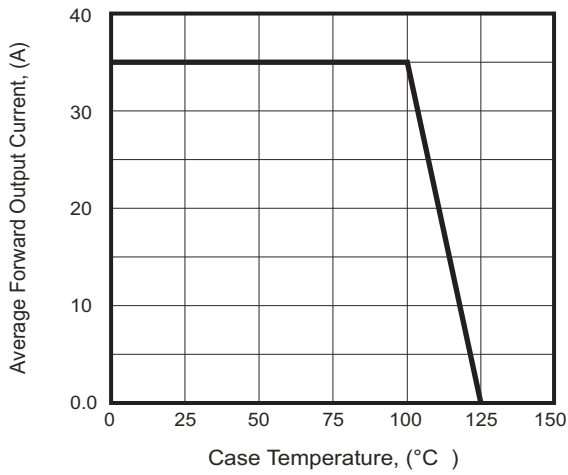

Fig.2 - Typical Forward Characteristics

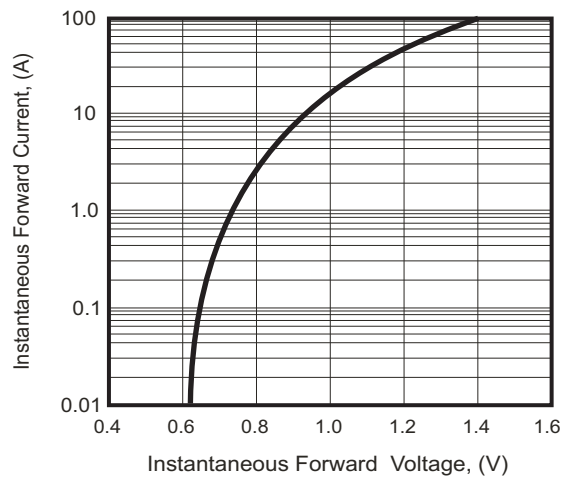

Fig.3 - Maximum Forward Surge Current

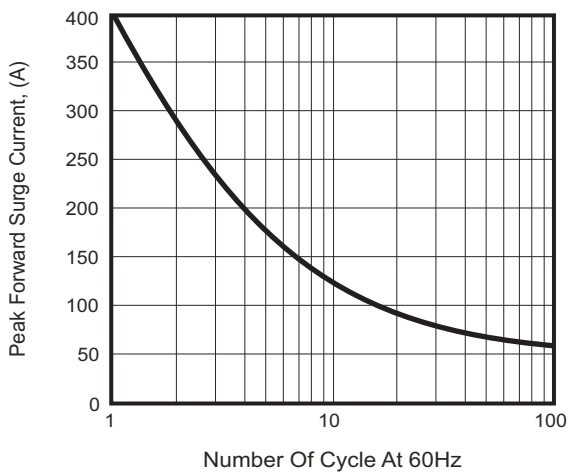
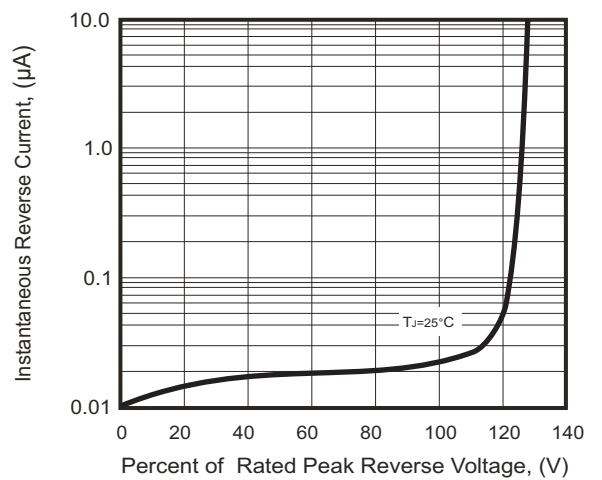
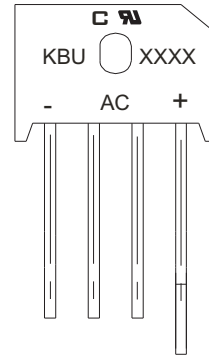

Fig.4 - Typical Reverse Characteristics



Marking Code

Part Number	Marking code
KBU35005-G	KBU35005
KBU3501-G	KBU3501
KBU3502-G	KBU3502
KBU3504-G	KBU3504
KBU3506-G	KBU3506
KBU3508-G	KBU3508
KBU3510-G	KBU3510



XXXX / XXXXX = Product type marking code
 □ = Compchip Logo

Standard Packaging

Case Type	BULK PACK	
	BOX (pcs)	CARTON (pcs)
KBU	400	2,400